

# MASTERCOOK

## ISTRUZIONI DI MONTAGGIO

| KEYKY22022HE

# BBQ A CARBONE KETTY









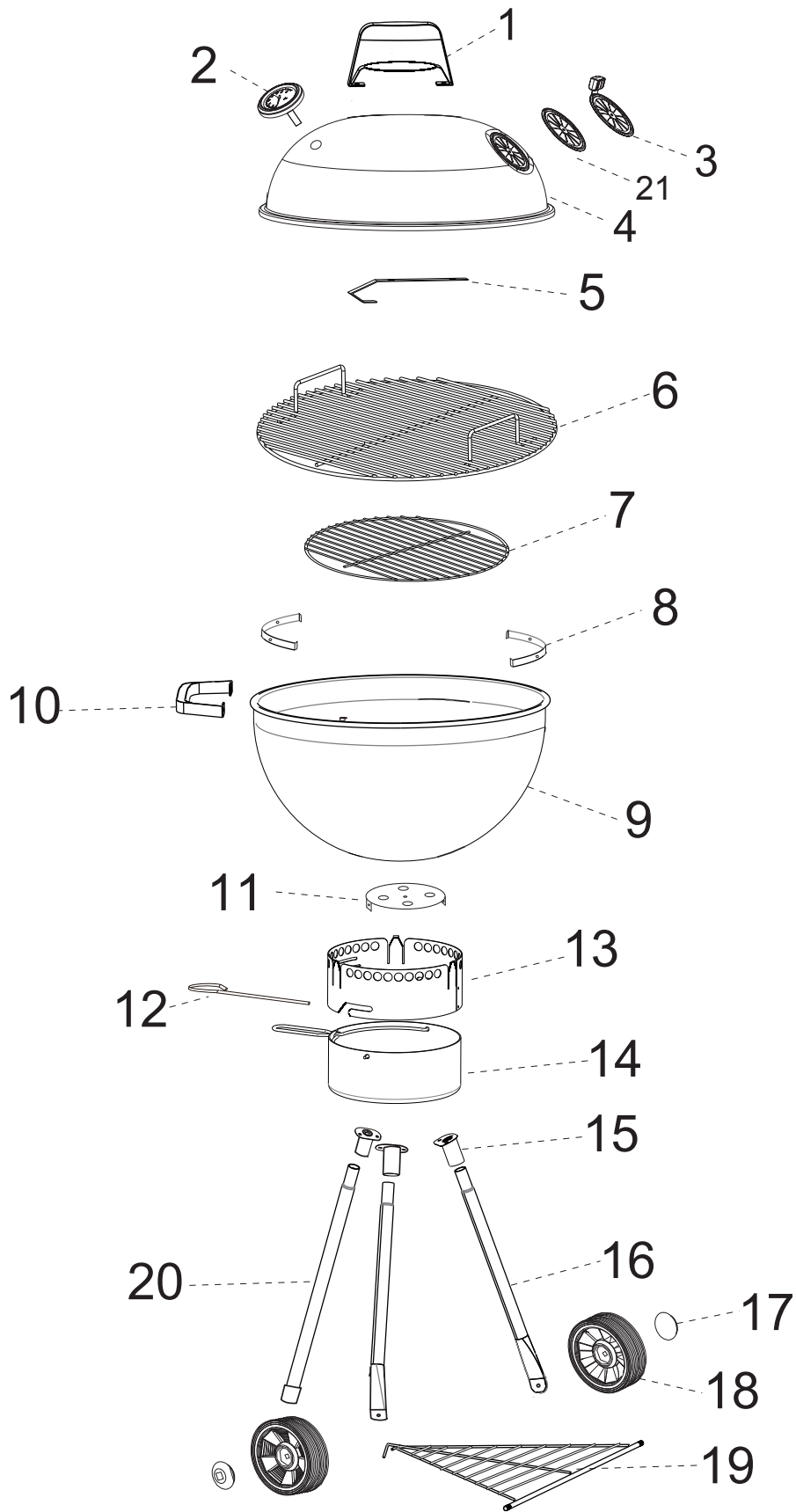













FR  
DONNEZ  
OU  
RECYCLEZ  
ASSOCIATION OU MAGASIN OU DÉCHÈTERIE











Adresses sur [quefairedemesdechets.fr](http://quefairedemesdechets.fr)

Importato da:  
Brigest SRL  
Via Lecce snc  
73024 Maglie (Lecce) Italy  
P.IVA: 03648000754  
[info@brigras.com](mailto:info@brigras.com)  
Made in PRC



## PARTI DEL BARBECUE

1		x 1	11		x 1
2		x 1	12		x 1
3		x 1	13		x 1
4		x 1	14		x 1
5		x 1	15		x 3
6		x 1	16		x 2
7		x 1	17		x 2
8		x 2	18		x 2
9		x 1	19		x 1
10		x 1	20		x 1
			21		x 1

A	M6X16		x13	F	φ 6X18		x4
B	φ6X16		x12	G	M6		x1
C	M6		x14	H	M6X35		x3
D	M5X12		x1	I	φ 6X25		x3
E	M5		x1	J	M10		x2

# MONTAGGIO

Step 1

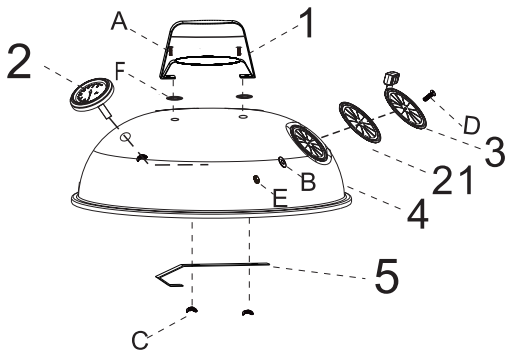

Step 2

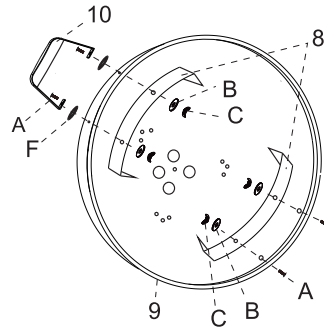

Step 3

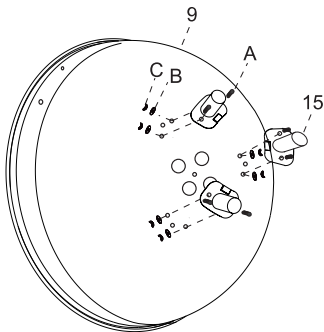

Step 4

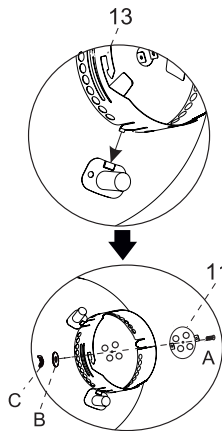

Step 5

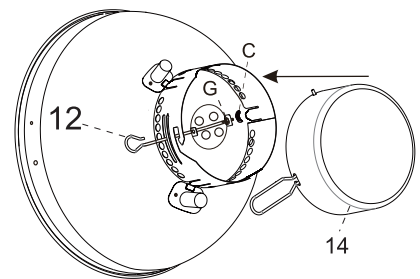

Step 6

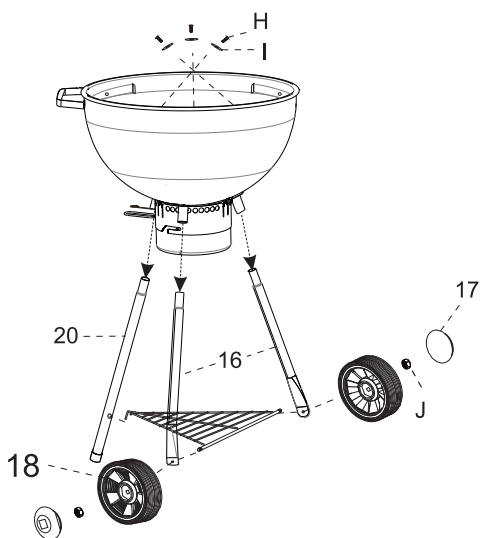

Step 7

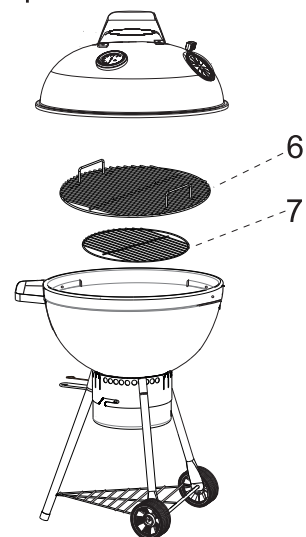

# MASTERCOOK

Importato da:  
Brigest SRL  
Via Lecce snc  
73024 Maglie (Lecce) Italy  
P.IVA: 03648000754  
info@brigos.com  
Made in PRC



Adresses sur [quefairedemesdechets.fr](http://quefairedemesdechets.fr)